

# Gigabit Transmission – What's the Limit?

Fanny Mlinarsky  
Hewlett Packard  
753 Forest Street, Marlborough, MA 01752  
508-786-9600

## **Introduction**

As Local Area Networking (LAN) technology advances into the realm of gigabit transmission, cabling infrastructure is evolving to address the new physical layer requirements of the new networks. This paper examines the signaling environment pertaining to the new generation gigabit transmission over twisted pair and fiber optic cabling and discusses methods of measuring the headroom of network applications in the field.<sup>1,2</sup>

## **Why Measure Headroom?**

Headroom is the measure of network robustness or its immunity to external interference. Insufficient headroom can result in excessive bit errors causing the network to operate at a noticeably diminished throughput or not at all. In simple terms, insufficient headroom can cause the network to be slow or unresponsive.

Headroom should be determined using a method specifically designed for the network of interest. One problem with generic certification tests<sup>3</sup> is that they do not measure the *overall* impact of the pertinent cabling parameters on the target application. A passing result on a certification test might cover up the fact that the headroom for the desired application is dangerously slim and that only a slight amount of external interference could render the channel unusable. On the other hand, a failing result might be misleading because despite the failure, the channel might offer sufficient headroom for the desired application<sup>4</sup>.

A customized network test can determine the precise headroom for the application of interest and indicate how reliably the application will operate.

## **Headroom vs. Data Rate**

In a channel of a fixed capacity, the available headroom decreases as the data rate increases. A network that operates at the maximum data rate supportable by the channel has zero headroom. In principle, the more data we try to squeeze through a channel of fixed capacity, the lower the headroom becomes.

---

<sup>1</sup> It is assumed that the reader is familiar with the new IEEE gigabit Ethernet signaling scheme or has read the white paper, "Gigabit Ethernet over Category 5" [4]. This paper can be found on [www.scope.com](http://www.scope.com).

<sup>2</sup> The term "application" is used to indicate the type of network (e.g. 1000Base-T application).

<sup>3</sup> Field certification is standardized in the TIA TSB67 [1] specification and its follow-on documents [2][3]

<sup>4</sup> Generic certification tests provide pass/fail results that apply to all standard networks designed to operate over the target cable category. However, due to the one-size-fits-all approach, generic certification tests can fail cabling that might be suitable for the application of interest. For example, an existing category 5 channel might fail the newly standardized return loss limit at a single frequency point but still have sufficient headroom to run gigabit Ethernet. Return loss in and of itself does not determine the application headroom. It is only one of several sources of noise [4] in a category 5 channel and should be considered in the context of other cable parameters.

Due to relatively low data rate, the familiar 10Base-T networks have always been robust and trouble-free which explains the general complacency of the LAN industry about application headroom. With the emergence of faster networks such as gigabit Ethernet<sup>5</sup>, this complacency will soon disappear and the LAN industry will be forced to pay more attention to channel quality and application headroom.

The following figure demonstrates how headroom in a channel such as category 5E decreases as a function of increasing data rate.

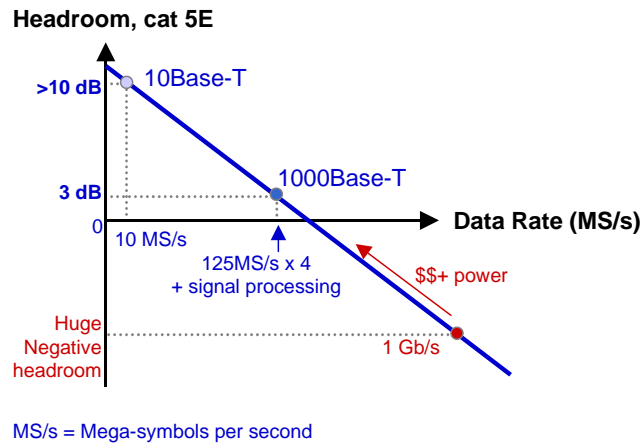

Figure 1: A conceptual example of throughput vs. headroom behavior of a category 5E channel. A Gb/s application implemented in a traditional way would have negative headroom but can be pushed into the positive-headroom territory by using signal processing as was done with gigabit Ethernet [4]. But even with signal processing the headroom decreases as the data rate increases.

The headroom of a particular application can be improved through signal processing but, according to the no-free-lunch theory, the addition of signal processing also increases the cost and power consumption of transceiver electronics.

Headroom is a general-purpose measure of available margin with respect to the cabling parameters that limit application throughput. Total throughput in a given communications channel is limited by the probability of bit errors due to noise and distortion in the channel. Noise and distortion, in turn, are a function of the signaling scheme and of the physical medium. Headroom is defined differently for twisted-pair and fiber-optic media.

### Headroom on Twisted-pair Cabling

Headroom of a twisted-pair channel is typically quantified in terms of the Signal to Noise Ratio margin [4] and is measured in dB. SNR margin is the difference between the SNR required to guarantee a desired Bit Error Rate (BER) and the total SNR available in the channel under test.

---

<sup>5</sup> Gigabit Ethernet is the emerging mainstream application. 1000Base-X is the main gigabit Ethernet standard covered by the IEEE 802.3z document. IEEE 802.3z has been approved in June of 1998 as an official IEEE standard. 1000Base-X specifies operation over fiber. 1000Base-T is the category 5 interface for 1000Base-X. 1000Base-T is covered by the IEEE 802.3ab draft document currently out for the IEEE 802.3 working group ballot.

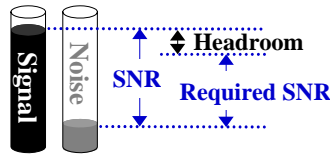

Figure 2: Conceptual depiction of headroom as the difference between the required SNR and the available SNR. This difference is also commonly known as the SNR margin.

On twisted pair, the sources of noise include channel properties such as near end crosstalk (NEXT), far end crosstalk (FEXT) and return loss. Ambient interference such as transient noise and other radiated emissions also contribute to noise.

Typically, the effects of channel parameters on a particular application are highly dependent on the signaling scheme. In the case of the 1000Base-T application [5] that transmits on all four pairs in full duplex [4], the noise environment is a function of NEXT from 3 adjacent pairs, FEXT from 3 adjacent pairs and channel return loss. In the case of 100Base-TX network, the primary source of noise is NEXT from only one pair.

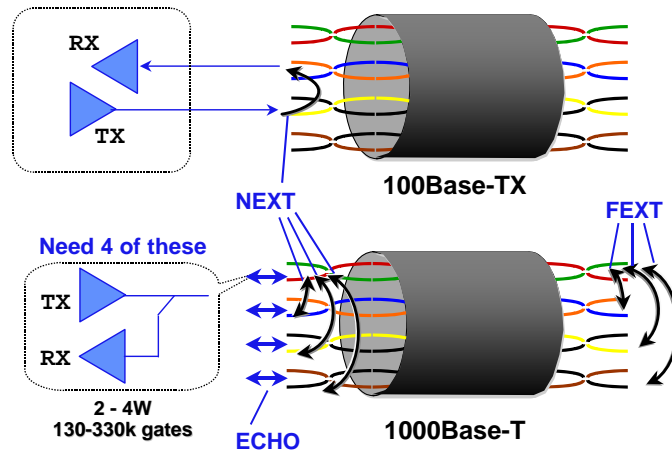

Figure 3: Because 100Base-TX transmits and receives on separate pairs and uses only two pairs, its primary source of noise is NEXT from the transmitting pair. 1000Base-T transmits and receives on all 4 pairs in full duplex and is, therefore, subject to 3 sources of NEXT, 3 sources of FEXT, and echo that is due to signal reflections proportional to channel return loss.

However, noise by itself does not determine the headroom of twisted-pair channels because SNR is a function of signal power and noise power. While crosstalk and return loss are the primary noise sources, channel attenuation determines the power of the data signal. Let's look at an example.

### 1000Base-T Application Headroom

The IEEE 802.3ab working group developing the 1000Base-T twisted pair gigabit Ethernet standard has analyzed the SNR margin of this new network by modeling the worst case category 5 cabling parameters and feeding these models as inputs to the model of transceiver signal processing logic (figure 4).

The limits for the relevant cabling parameters were identified through a joint effort by the IEEE 802.3ab working group and the TIA TR41.8.1 Systems task group. IEEE 802.3ab performed complex analysis of the available headroom for 1000Base-T using what they considered worst case category 5 specifications<sup>6</sup>.

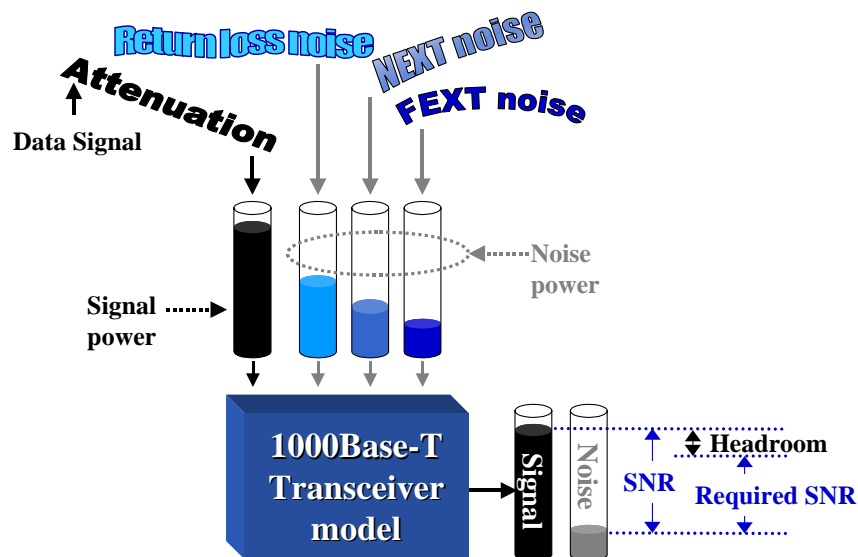

Figure 4: The IEEE model for calculating 1000Base-T SNR margin. Return Loss, NEXT and FEXT contribute to total noise and undergo signal processing-based reduction inside the transceiver. Cable attenuation determines the power of the data signal. The SNR required to achieve the Bit Error Rate (BER) of  $10^{-10}$  is subtracted from the total SNR to calculate the available headroom.

If attenuation, return loss, NEXT and FEXT are at the category 5 limits, then the headroom according to the model is only 2 dB [4]. This slim 2 dB margin is a theoretical worst case and would only happen on the longest allowable cable of 100 meters. But even at 100 meters, a channel having all of its parameters worst case is statistically extremely rare. Most twisted pair installations are shorter than 100 meters and exhibit considerably less than worst case attenuation. The headroom computed by the model is a direct function of attenuation or cable length. This can be easily demonstrated by keeping the noise models -- return loss, NEXT and FEXT -- fixed at worst case while changing the attenuation by varying the channel length.

An experiment was performed to demonstrate the effect of attenuation on headroom. Attenuation models (figure 5) based on measured attenuation of four different channels - 0.3, 20, 50 and 100 meters - were input to the IEEE transceiver model. The return loss and NEXT models were kept at worst case and the FEXT model was adjusted to account for the variation in the attenuation.<sup>7</sup> The results show that the available headroom in a twisted pair channel is a function of cable attenuation or length.

<sup>6</sup> IEEE 802.3ab had to make some assumptions regarding the channel limits for return loss and far end crosstalk (FEXT) because the TIA limits for these parameters were not standardized prior to the emergence of 1000Base-T.

<sup>7</sup> The FEXT model used by the IEEE was based on maximum allowable channel attenuation. As attenuation decreases, the FEXT interference increases. TIA has defined the Equal Level Far End Crosstalk (ELFEXT) parameter to account for the effect of attenuation on FEXT [4].

Table 1: Modeling of gigabit Ethernet headroom vs. category 5 channel length

Length (m)	Headroom (dB)
0.3	11.4
25	9.8
50	7.0
100 (non-worst case)	4.0
Worst case model	2.0

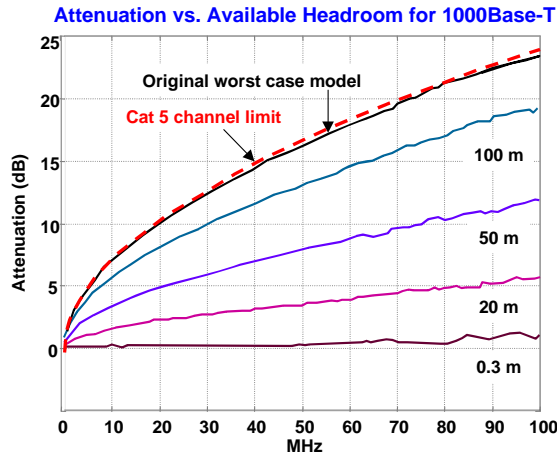

Figure 5: Measured attenuation responses of four test channels - 0.3, 20, 50 and 100 meters. Also shown is the worst case attenuation model used in the IEEE study.

Based on this modeling exercise, we can interpolate the following headroom vs. distance curve for a typical category 5 channel using the data points from table 1:

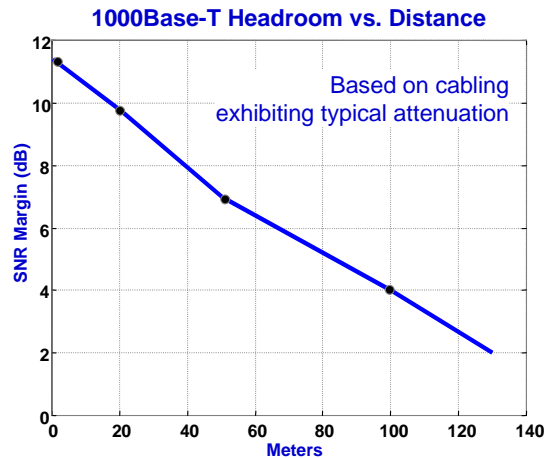

Figure 6: Expected typical headroom vs. distance behavior of gigabit Ethernet over category 5. This curve is based on the SNR margin computed using the IEEE model for the channel lengths listed in table 1.

Based on the above exercise, we can conclude that average length channels exhibit respectable headroom even under absolute worst case return loss and crosstalk conditions. Furthermore, typical cabling tends to have less than maximum allowable attenuation even at 100 meters. Therefore, it is likely that most installed category 5 channels will support gigabit Ethernet with sufficient headroom even if the newly defined [2][3] field certification fails.<sup>8</sup>

## Summary – Twisted-pair Headroom

Headroom in twisted-pair environment is expressed in terms of SNR margin and measured in dB. SNR margin depends on the signaling scheme of the target application and is a function of crosstalk and return loss properties of the channel. Twisted pair headroom is also a function of channel length and tends to be better for shorter channels.

### **Headroom on Fiber-optic Cabling**

The capacity or modal bandwidth of fiber-optic cable is specified as a bandwidth-distance product measured in MHz • km units. Distance is a factor in the modal bandwidth specification because in fiber-optic channels, the distance traveled by the data signal determines the degree of distortion the signal undergoes.<sup>9</sup> The longer the channel, the more distorted the signal becomes as it travels from the transmitter to the receiver. In the receiver, distortion is translated into time-domain jitter that ultimately limits the data rate.

The noise environment in fiber optic channels is more benign than in twisted pair channels. The ambient noise on fiber consists mainly of interfering light leaking through connecting hardware and there is no twisted-pair equivalent of crosstalk, transient noise or electromagnetic interference. For this reason, SNR is not the key metric of fiber-optic channel quality.

The key metric of headroom for fiber optic networks is the length of the channel since the modal bandwidths of the installation (MHz • km) and the data rate of the target application are fixed.

## Multimode and Single-mode Fiber

There are two types of fiber optic cabling -- multimode (MMF) and single-mode (SMF). Light propagates through the core (central portion) of optical fiber. Multi-mode fiber, with a typical core diameter of 62.5 microns<sup>10</sup> or 50 microns, is designed for coupling light from low cost LED-based transmitters. Single-mode fiber has a core diameter of 10 microns and is only suitable for laser-based transmission. Much of the installed base of optical fiber supporting LAN backbones is multi-mode because most of the current-generation 10 or 100 Mb/s LAN equipment is LED-based.

Gigabit Ethernet [6] operating at 1.25 Gb/s is too fast for LEDs and requires the use of lasers. Traditionally, laser-based data transmission has been used with single-mode fiber. The 1000Base-X standard has introduced laser-based transmission over multimode fiber and this new type of transmission has introduced new types of physical layer issues.

---

<sup>8</sup> Given the uncertainty of whether the cabling in the walls today will meet the new limits for return loss and far end crosstalk (FEXT), it probably pays to go beyond the generic certification and measure the actual application headroom for gigabit Ethernet.

<sup>9</sup> The specific type of optical signal distortion is called dispersion (defined below).

<sup>10</sup> 1 micron = 10<sup>-6</sup> meter

## Differential Mode Delay Issue

The main issue with laser-based data transmission over MMF is differential mode delay (DMD). DMD is the effect produced by injecting a laser beam directly into the center of the core. Due to the constitution of the core, the laser beam can be split into two or more modes (or paths) of light. The different modes can be subject to different propagation delays and arrive at the receiver with a time skew, which causes jitter.

Single-mode fiber due to its narrow 10-micron core minimizes the distortion by allowing only a single mode of light to propagate. Distortion is typically not a problem for single-mode fiber. Signal attenuation is the limiting factor for single-mode transmission and for this reason single mode fiber can support substantially longer distances than multimode fiber.

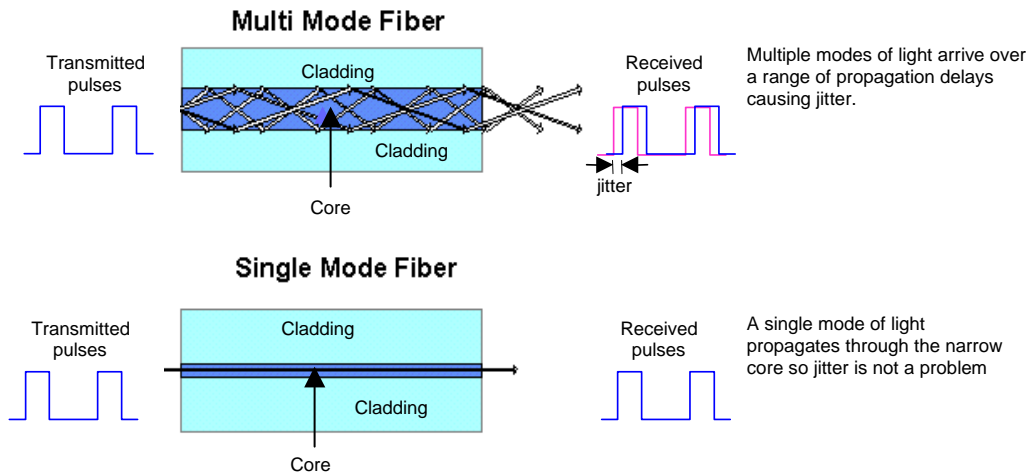

Figure 7: Demonstration of the jitter build-up when operating over multimode fiber

DMD should not be confused with dispersion. Dispersion is a well understood phenomenon that produces a widening of the transmitted pulse as different wavelengths of light propagate at slightly different velocities through the fiber core and arrive at the end of the fiber with a time skew. The wider the spectrum of the optical source the greater the effect of dispersion. DMD is the result of beam-splitting caused by structural constitution of the core. Both dispersion and DMD produce the same effect - jitter that builds-up as a function of fiber length. However, DMD is the dominant contributor to jitter in 1000Base-X networks because the laser source is too narrow to produce any significant dispersion.

To address this issue of DMD, the 1310 nm 1000Base-LX installations must use a specialized patch cord<sup>11</sup>. This patch cord is designed to introduce an offset to the laser launch to direct the laser beam off center into the multi-mode fiber.

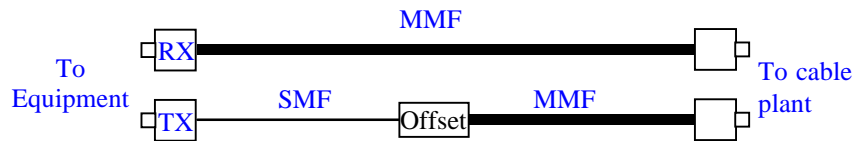

Figure 8: 1000 Base-LX fiber patch cord with offset for transmit laser launch

<sup>11</sup>The offset patch cord only works for the 1000Base-LX version of gigabit Ethernet that uses a 1310 nm laser source. 1000Base-SX service uses an 850-nm laser that cannot be transmitted over single-mode fiber and therefore cannot be launched into the SMF portion of the offset patch cord.

## 1000Base-X Physical Layer Topologies

The IEEE 802.3z standard [6] defines two types of services – 1000Base-SX operating at 850 nm and 1000Base-LX operating at 1310 nm – both laser-based.

The channel length limits summarized in table 2 are based on a thorough study of the DMD effects. The length restrictions for multi-mode fiber are a function of the modal bandwidth. Single-mode fiber only supports the 1310-nm 1000Base-LX service.

Table 2: Maximum length and attenuation specifications for different versions of Gigabit Ethernet over various types of fiber optic media

Gigabit Ethernet Specification	Type of Fiber	Wave-length (nm)	Fiber Core Size (microns)	Modal Bandwidth (MHz • km)	Maximum Distance (m)	Attenuation (dB)
1000Base-SX	MMF	850	50	400	500	3.37
				500	550	3.56
			62.5	160	220	2.38
				200	275	2.60
1000Base-LX	MMF	1310	50	400,500	550	2.35
			62.5	500	550	2.35
	SMF	1310	10		5,000	4.57

It is interesting to note that the attenuation limits listed in table 2 are based on the supported distance and are considerably tighter than would be tolerated by the dynamic range of the transceivers. For example, link power budget, based on the 1000Base-X specifications for transmitter launch power and receiver sensitivity, is 7.5 dB for multi-mode fiber. However, the channel attenuation limits in table 2 are considerably lower than the link budget would suggest since they were specified on the basis of maximum distance.

These attenuation limits are very tight by normal LAN standards and the TIA TR41.8.1 fiber optic systems task group has expressed concern that currently standardized field testing procedures might falsely fail many acceptable fiber optic links.

### Summary – What's the Limit?

The limit on gigabit transmission is best expressed in terms of application headroom. The precise definition of headroom is a function of the signaling scheme, the physical medium and the properties of the physical medium pertinent to the application of interest.

Application headroom can be measured in the field using network tests specifically designed for each application of interest. Generic field certification, because of its one-size-fits all approach, does not provide any information about the available application headroom. We have seen that a certification test for 1000Base-T can pass with no indication of trouble even if the SNR margin is only 2 dB.

Application headroom should be sufficient to ensure that the required Bit Error Rate (BER) is maintained even if the environment is noisy or hostile. Electrical motors, air conditioning equipment, walkie-talkies, cellular phones, adjacent networking services and other sources of noise can interfere with data



transmission causing bit errors. Excessive bit errors can in turn cause re-transmissions of data, dropping the ultimate throughput to a fraction of what is expected. In the presence of excessive bit errors, the network can become slow or unresponsive. For robust operation, it is desirable to maintain the SNR margin of twisted-pair networks at 5 dB or better.

In twisted-pair channels, SNR margin is the key indicator of application headroom. However, the noise environment is unique to each network application. For example, a 1000Base-T test must take into account 3 sources of NEXT, 3 sources of FEXT, return loss, attenuation and the signal-processing-based noise cancellation. A test designed for a more traditional network such as 100Base-TX would only require the analysis of NEXT and attenuation on the two signal pairs. Thus, the test of application headroom must be uniquely designed for each application.

In fiber-optic channels, the key indicator of application headroom is the length of the channel. From the example of 1000Base-X application, we have seen that the channel limits for this network are actually based on length. Noise and signal power are not as significant for fiber optic applications as they are for twisted-pair applications. Length is the key metric of channel quality for fiber installations and the length limit for the target fiber-optic application should be strictly observed.

Regardless of the physical medium, each network test must be uniquely optimized for the target application. Headroom is an important measure of network robustness particularly as the industry is attempting to squeeze the last drops of performance from the installed base. In the case of applications such as gigabit Ethernet, some key parameters have never been measured in the field and the inter-standards gaps [8] between the networking and the cabling standards are ever-present as demonstrated by the example of 1000Base-X field testing. Some older gaps are being sealed while the new ones form as the new standards are created.

Based on the work performed by the standards organizations, we can be assured that most installations – fiber-optic and twisted-pair – will support the new gigabit networks. But how robust will these networks be? Will they deliver the expected gigabit throughput under adverse channel conditions? The only reliable way of knowing is through measuring application headroom for each network of interest.

## References

- [1] TIA/EIA Telecommunications Systems Bulletin, TSB67, "Transmission Performance Specifications for Field Testing of Unshielded Twisted-Pair Cabling Systems", October 1995
- [2] TIA TSB XX (draft) "Additional Transmission Performance Specifications for 100  $\Omega$  4-Pair Category 5 Cabling", 5/98
- [3] TIA-568-A Addendum 4 (draft) "Additional Transmission Performance Specifications for 4-Pair 100  $\Omega$  Enhanced Category 5 Cabling", 5/98
- [4] "Gigabit Ethernet over Category 5 Part II - Channel Environment and SNR Margin", 6/98
- [5] IEEE 802.3ab/D3.0, "Physical Layer specification for 1000 Mb/s operation on four pairs of Category 5 or better balanced twisted pair cable (1000Base-T)", 6/98
- [6] IEEE 802.3z/D5.0 (1000Base-X) "Supplement to Carrier Sense Multiple Access with Collision Detection (CSMA/CD) Access Method & Physical Layer Specifications—Media Access Control (MAC) Parameters, Physical Layer, Repeater and Management Parameters for 1000 Mb/s Operation", 5/98
- [7] EIA/TIA-526-14A (draft), "Optical Power Loss Measurements of Installed Multimode Fiber Cable Plant", 1/96
- [8] "The Inter-Standard Gap", IWCS Proceedings, 1996

## Speaker's Biography

Fanny Mlinarsky  
R&D Manager  
Hewlett Packard  
753 Forest Street  
Marlborough, MA 01752

Fanny Mlinarsky has held a number of Engineering and Engineering Management positions at the leading communications and test equipment companies including Chipcom, Concord Communications and Teradyne. Since the acquisition of Scope Communications by Hewlett Packard, she has been managing product development at HP. Mlinarsky has been involved with the development of hand held test tools used by cable installers and network maintenance technicians since 1993. In her 16 years of industry experience, she has been actively participating in the development of networking and cabling standards at TIA, IEEE, ANSI, ISO and IEC.